

SAFETY NOTICE

This safety notice summarizes information basic to the safe operation of the equipment described in this manual. The international symbol displayed above is a reminder that all safety instructions should be read and understood before installation, operation, maintenance, or repair of this centrifuge. When you see the symbol on other pages, pay special attention to the safety information presented. Observance of safety precautions will also help to avoid actions that could damage or adversely affect the performance of the centrifuge.

Safety During Installation and/or Maintenance

This centrifuge is designed to be installed by a Beckman Coulter Field Service representative. Installation by anyone other than authorized Beckman Coulter personnel invalidates any warranty covering the instrument.

Any servicing of this equipment that requires removal of any covers can expose parts which involve the risk of electric shock or personal injury. Make sure that the power switch is off and the centrifuge is disconnected from the power source, and refer such servicing to qualified personnel.

Use the anchoring system to secure the centrifuge in place. The anchoring system is designed to reduce the possibility of injury or damage that could result from instrument movement in the event of a major rotor mishap.

Do not replace any centrifuge components with those not specified for use on this instrument.

Electrical Safety

To reduce the risk of electrical shock, this equipment uses a three-wire electrical cord and plug to connect the centrifuge to earth ground. To preserve this safety feature:

- Make sure that the matching wall outlet receptacle is properly wired and earth-grounded. Check that the line voltage agrees with the voltage listed on the name-rating plate affixed to the centrifuge.
- Never use a three-to-two wire plug adapter.

This centrifuge is not designed for use with materials capable of developing flammable or explosive vapors. Do not centrifuge such materials (such as chloroform or ethyl alcohol) in this centrifuge nor handle or store them within the required 30-cm (1-ft) area surrounding the centrifuge.

Mechanical Safety

For safe operation of the equipment, observe the following:

- Use only the rotors and accessories designed for this centrifuge.
- Do not exceed the maximum rated speed of the rotor in use.
- Do not lift or move the centrifuge while the rotor is spinning.
- NEVER attempt to slow or stop the rotor by hand.
- NEVER attempt to override the door interlock system while the rotor is spinning.
- In the event of a power failure, do not attempt to retrieve the sample from the centrifuge for at least 1 hour. Then follow the instructions for safe recovery in Section 4, TROUBLESHOOTING

Chemical and Biological Safety

Normal operation may involve the use of solvents and test samples that are pathogenic, toxic, or radioactive. Such materials should not be used in this centrifuge, however, unless all necessary safety precautions are taken.

- Observe all cautionary information printed on the original solution containers prior to their use.
- Handle body fluids with care because they transmit disease. No known test offers complete assurance that they are free of microorganisms. Some of the most virulent—Hepatitis (B and C) and HIV (I–V) viruses,

M N

SECTION 3:	OPERATION	
	Summary of Run Procedures	3-2
	Programmed Run	3-2
	Manual Run	3-3
	Preparation	3-3
	Installing the Rotor	3-4
	Manual Operation	3-5
	Selecting a Rotor	3-5
	Entering Run Speed	3-6
	Entering Run Time	3-6
	Entering Run Temperature	3-7
	Entering Acceleration and Deceleration Rates	3-8
	Starting a Run	3-9
	Programmed Operation	3-9
	Creating a New Program	3-10
	Starting a Programmed Run	3-10
	Recalling and Changing a Program	3-11
SECTION 4:	TROUBLESHOOTING	
	User Messages	4-1
	Retrieving Your Sample in Case of Power Failure	4-4
SECTION 5:	MAINTENANCE	
	Instrument Care	5-1
	Maintenance	5-2
	Cleaning	5-2
	Decontamination	5-3
	Sterilization and Disinfection	5-3
	Replacing the Air Filter	5-4
	Circuit Breaker and Fuses	5-5
	Storage and Transportation	5-5
	Storage	5-5
	Supply List	5-6
	Replacement Parts	5-6
	Supplies	5-6

Warranty

Illustrations and Tables

	Page
Figure 1-1. The Avanti® J-E Centrifuge	1-1
Figure 1-2. Control Panel	1-4
Figure 2-1. Dimensions of the Avanti® J-E Centrifuge	2-2
Figure 2-2. Single-Phase Power Connection	2-3
Figure 4-1. Manual Door Release	4-6
Figure 5-1. Air Filter Replacement	5-4
Table 4-1. Diagnostic Message Chart	4-2

CERTIFICATION

To ensure full system quality, Beckman Coulter Avanti® J-E centrifuges have been manufactured in a registered ISO 9001 or 13485 facility. They have been designed and tested to be compliant (when used with Beckman Coulter rotors) with the laboratory equipment requirements of applicable regulatory agencies. Declarations of conformity and certificates of compliance are available at www.beckmancoulter.com.

SCOPE OF MANUAL

This manual is designed to familiarize you with the Avanti® J-E centrifuge, its functions, specifications, operation, and routine operator care and maintenance. We recommend that you read this entire manual, especially the SAFETY NOTICE and all safety-related information, before operating the centrifuge or performing instrument maintenance.

**WARNING**

Used whenever an action or condition may potentially cause personal injury or loss of life. Mechanical damage may also result.

**WARNING**

Indicates high voltage or risk of electric shock. Refer servicing of all areas displaying either symbol to service personnel.

TYPOGRAPHIC CONVENTIONS

Certain typographic conventions are used throughout this manual to distinguish names of user interface components, such as keys.

- Keynames (for example, `[START]` or `[PROGRAM]`) appear in capital letters within brackets.

CFC-FREE CENTRIFUGATION



To ensure minimal environmental impact, no CFCs are used in the manufacture or operation of Avanti J-E centrifuges.

RADIO INTERFERENCE

This equipment has been tested and found to comply with the limits for a Class A digital device, pursuant to Part 15 of FCC Rules. These limits are designed to provide reasonable protection against harmful interference when the equipment is operated in a commercial environment. This equipment generates, uses, and can radiate radio frequency energy and, if not installed and used in accordance with this instruction manual, may cause interference to radio communications. Operation of this equipment in a residential area is likely to cause interference, in which case the user will be required to correct the interference at his own expense.

CANADIAN REGULATIONS

This equipment does not exceed Class A limits for radio noise emissions from digital apparatus set out in the radio interference regulations of the Canadian Department of Communications.

Le présent appareil numérique n'émet pas de bruits radioélectriques dépassant les limites applicables aux appareils numériques de Classe A prescrites dans le règlement sur le brouillage radioélectrique édicté par le Ministère des Communications du Canada.

RECYCLING LABEL



Note: On the instrument, the triangle background is yellow rather than gray.

This symbol is required in accordance with the Waste Electrical and Electronic Equipment (WEEE) Directive of the European Union. The presence of this marking on the product indicates:

- 1) the device was put on the European market after August 13, 2005 and
- 2) the device is not to be disposed of the municipal waste collection system of any member state of the European Union.

It is very important that customers understand and follow all laws regarding the proper decontamination and safe disposal of electrical equipment. For Beckman Coulter products bearing this label please contact your dealer or local Beckman Coulter office for details on the take back program that will facilitate the proper collection, treatment, recovery, recycling and safe disposal of the device.

DESCRIPTION

CENTRIFUGE FUNCTION

The Avant®

Description

- Rapid sedimentation of protein precipitates, large particles, and cell debris.
- Preparation of subcellular organelles such as mitochondria, nuclei, chloroplasts, and crude microsomes.
- Separation of blood cells and cellular components.
- Gradient separation, for example, Ficoll-Hypaque and Percoll.

The Avanti J-E is microprocessor controlled, providing interactive operation. The instrument design features a brushless switched-reluctance drive motor, a temperature control system with automatic temperature compensation unique to each compatible rotor, and selectable acceleration and deceleration rates.

Manual and programmed operation are available.

- In manual operation, you enter the individual run parameters before beginning each run.
- In programmed operation, you can duplicate runs quickly and accurately by selecting one of the programs previously entered into the program memory.

User messages and/or audible signals are provided to alert you to conditions that may need attention.

HOUSING AND DOOR

The instrument housing is made of steel and molded structural foam. The door and structural-foam coverings are finished with polyurethane enamel.

ROTOR CHAMBER

The rotor chamber is made of stainless steel to resist corrosion. A rubber gasket around the chamber opening ensures sealing. (Instrument gaskets have not been qualified as bioseals for aerosol containment.)

VACUUM

The friction reduction system (FRS) uses a mechanical rotary vane vacuum pump to reduce chamber pressure to approximately one-half atmosphere. The pump turns on when run is started, before rotor friction reaches a high level. Vacuum the chamber is vented automatically during rotor deceleration.

TEMPERATURE CONTROL

The temperature control system cools by circulation of a non-CFC-based refrigerant. The system is activated when the centrifuge power is on and when the door is closed and latched.

A thermistor in the rotor chamber continuously monitors the chamber temperature. The system calculates the chamber temperature required to maintain the set rotor temperature, $\pm 2^{\circ}\text{C}$. Although the chamber temperature fluctuates during operation, the rotor's large mass keeps the sample temperature

DRIVE

The drive shaft is belt driven by a brushless, high-torque, switched-reluctance motor. The instrument's resilient suspension minimizes disturbance of the sample during acceleration and deceleration, and reduces damage to the drive shaft if an imbalance occurs during centrifugation.

CONTROLS AND INDICATORS

POWER SWITCH

The power switch, located on the right panel of the centrifuge, controls electrical power to the centrifuge. It is also a circuit breaker that will trip to cut off power in the event of a power overload. The power switch must be turned off before the chamber door can be opened.

CONTROL PANEL

The control panel (see Figure 1-2) is mounted at an angle on the centrifuge front for easy visibility and access. It is used to enter run parameters via function keys and a keypad, and to display run parameters, program information, and user messages.

Figure 1-2. Control Panel

Digital Displays

The displays provide run information, user messages, and diagnostics.

- During a run, they show the actual (real-time) operating conditions.
- When the run parameters are ~~to be~~ entered, they show the set values selected. Set values can be recalled during operation by pressing [SHOW SET]. After 5 seconds, the displays return to actual conditions.

(SPEED)

Indicates rotor speed in revolutions per minute (rpm) or in relative centrifugal field, a term describing the ratio of the centrifugal acceleration at a specified radius and speed to the standard acceleration of gravity (RCF g).

(TIME)

- In a timed run, indicates th

Description

(PROGRAM)

- During setup—when the [PROGRAM] key is pressed a program number (one of nine possible) can be entered.
- During centrifugation—the number of the program being run is displayed.

Run-Parameter Keys

Run-parameter keys are used to enter specific run information as follows.

Pressed to display scrolling list of compatible rotors and rotor entry codes. Can be pressed repeatedly to scroll more quickly through the rotor list.

If the display shows speed in rpm, the key is pressed once to enter run speed (using the keypad) in rpm (revolutions per minute); pressed twice to enter run speed in RCF (relative centrifugal field). If the display shows speed in RCF, the key is pressed once to enter speed in RCF or twice to enter speed in rpm.

Pressed to enter run time using the keypad. When [



The centrifuge has two acceleration profiles: MAX—maximum acceleration from 0 rpm to set speed, or SLOW—slow acceleration from 0 to 500 rpm, followed by maximum acceleration to set speed. The [ACCEL] key is used to select the maximum acceleration or slow acceleration, provided to maintain optimum separation.



The centrifuge has three deceleration profiles: MAX—full dynamic braking to 0 rpm; SLOW—brake to 500 rpm followed by reduced braking to a gentle stop; OFF (stop from set speed to stop). The [DECEL] key is used to select the deceleration rate provided to maintain optimum separation.



A toggle switch used to enter into and exit out of the program mode to create or recall programs. When the key is pressed, the program number can be selected using the keypad.



Saves the program in memory after program run parameters have been entered.

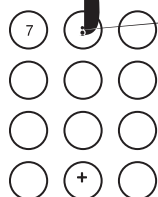

The keypad is used to enter numerical run parameters, to enter or recall a program number, and to select acceleration and/or deceleration rates. In addition to keys 0 through 9, the keypad includes plus or minus/decimal key and [CE] (clear entry) key.

The [±.] key is used to enter temperature setting below 0°C (for example, -2°C), or to enter a decimal point in a rotor entry code, depending on the parameter key selected.

The [CE] (clear entry) key clears any parameter on the display. Pressing [CE] will also clear some diagnostic messages. If a diagnostic message does not clear when [CE] is pressed, see Section 4, TROUBLESHOOTING

The [ENTER] key can be pressed to save parameter inputs to system memory during manual run setup and to start the centrifuge ([ENTER], then [START] must be pressed to start the centrifuge).

Description



Pressed during a run to display set values for 5 seconds.



Pressing [ENTER], then [START] begins the run. ([START] must be pressed within 5 seconds of pressing [ENTER].) This key combination can also be used to abort the acceleration process and restart the centrifuge.

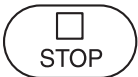

Can be pressed at any time while the rotor is spinning to terminate a run. The centrifuge decelerates to a complete stop according to the deceleration setting. The green light next to the key flashes while the rotor decelerates. An audio indicator sounds when the rotor comes to a complete stop.



Locks and unlocks the door (The instrument will not accept the open command if the rotor is spinning.)

SAFETY FEATURES

The Avanti J-E centrifuge has been designed and tested to operate safely indoors at altitudes up to 200m (6 562 ft). Safety features include the following.

DOOR

The steel and structural foam door has an electromechanical door-locking mechanism, with dual latches, to prevent operator contact with a spinning rotor. When the door is closed and [DOOR] is pressed, the latches automatically engage (The LED will come on.) It can be unlocked only by pressing [DOOR], and opened only when the power is on and the rotor is at rest. In the event of a power failure, the door lock can be manually tripped for sample recovery (see Section 4, TROUBLESHOOTING).

PROTECTIVE RING

A structural steel ring surrounding the rotor chamber provides full operator protection.

IMBALANCE DETECTOR

An imbalance detector monitors the rotor during the run, causing automatic shutdown if rotor loads are severely out of balance. At low speeds, an incorrectly loaded rotor can cause an imbalance. Rotor instability can also occur if the instrument is moved, or if it is not resting level on the floor (see Section 4.4 TROUBLESHOOTING).

OVERSPEED AND ROTOR IDENTIFICATION SYSTEM

A rotor identification system prevents the installed rotor from running above its maximum rated speed. During acceleration the microprocessor checks the magnetic rotor identification. If the system identifies a rotor different than the one entered by the user, and the set speed is above the maximum for the identified rotor, the system will reduce the set speed to the maximum for the installed rotor.

A second check, based on rotor physical properties, is performed during acceleration. Speed is limited to the maximum safe speed of the identified rotor group.

NOTE

Some rotors manufactured before January, 2002, may not have magnets installed. Based on the rotor property grouping, these rotors may be limited to a lower speed than the rated speed.

NAME RATING PLATE

A name rating plate is affixed to the rear of the instrument. Always mention the serial number and model number when contacting Beckman Coulter regarding your Avanti J-E centrifuge.

Description

AVAILABLE ROTORS

Refer to the applicable rotor manual for complete rotor descriptions.

Rotor Profile and Description	Rotor Entry Code	Max RPM ^a	Max RCF (ug)
-------------------------------	------------------	----------------------	--------------

^aBased on a solution density of 1.2 g/mL in all rotors.

^bMaximum speed for rotor in the Avanti J-E centrifuge.

^cMaximum speed for rotor at 25°C ambient temperature and 95 percent humidity.

^dMaximum speed for the Avanti J-E for the rotor with magnets; without magnets maximum speed is 14 000 rpm. (Maximum speed at 2°C in the Avanti J-E is 14 000 rpm.)

^eMaximum speed for rotor without magnets is 13 000 rpm.

^fPerformance for the F14BCI-14x50 rotor in the Avanti J-E is as follows: 12 minimum at 14 000 rpm (at 35°C ambient temperature); maximum at 13 000 rpm (35°C ambient).

^gMaximum speed for rotor without magnets is 6 300 rpm.

Description

Rotor Profile and Description	Rotor Entry Code	Max RPM ^a	Max RCF (ug)	Max Capacity	Rotor Manual Number
JLA-16.250 Fixed Angle, 25° (6 place) r _{max} = 134 mm	16.25	16 000 ^d (14 000 @ 2°C) ^c	38 400	6 u250 mL	J-TB-072
JA-14 Fixed Angle, 25° (6 place) r _{max} = 137 mm	14	14 000	30 100	6 u250 mL	J-TB-004
F14BCI-14x50cy Fixed Angle, 34° (14 place) ^f r _{max} = 153 mm	50	14 000	33 500	14 u50 mL	—
F14BCI-6x250y Fixed Angle, 23° (6 place) r _{max} = 137 mm	250	14 000	30 000	6 u250 mL	—
JA-12 Fixed Angle, 35° (12 place) r _{max} = 144 mm	12	12 000	23 200	12 u50 mL	J-TB-051
JA-10 Fixed Angle, 25° (6 place) r _{max} = 158 mm	10	10 000 ^g	17 700	6 u500 mL	J-TB-006

^a Maximum speeds are based on a solution density of 1.2 g/mL in all rotors.

^b Maximum speed for the rotor in the Avanti J-E centrifuge.

^c At 35°C ambient temperature and 95 percent humidity.

^d Maximum speed in the Avanti J-E for the rotor with magnets; without magnets maximum is 14 000 rpm. (Maximum speed at 2°C in a 50-Hz centrifuge is 14 000 rpm.)

^e Maximum speed for rotor without magnets is 13 000 rpm.

^f Temperature performance for the F14BCI-14x50cy rotor in the Avanti J-E is as follows: 12 minimum at 14 000 rpm (at 35°C ambient), 4°C minimum at 13 000 rpm (35°C ambient).

^g Maximum speed for rotor without magnets is 6 300 rpm.

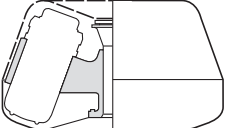
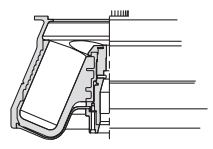
Rotor Profile and Description	Rotor Entry Code	Max RPM ^a	Max RCF (ug)	Max Capacity	Rotor Manual Number
JLA-10.500 Fixed Angle, 20° (6 place)  $r_{\max} = 166 \text{ mm}$	10.5	10 000 ^g	18 600	6 u500 mL	J-TB-048
F10BCI-6x500y Fixed Angle, 23° (6 place)  $r_{\max} = 158 \text{ mm}$	500	10 000	17 696	6 u500 mL	—
JLA-9.1000 Fixed Angle, 20° (4 place) $r_{\max} = 185 \text{ mm}$	9.1	6 300 ^b	8 230	4 u1000 mL	J-TB-073
JS-13.1 Swinging Bucket (6 place) $r_{\max} = 140 \text{ mm}$	13	13 000 (12 000 @ 2°C) ^c	26 500	6 u50 mL	J-TB-036
JS-5.3 Swinging Bucket (4 place) $r_{\max} = 194.8 \text{ mm}$	5.3	5 300	6 130	4 u500 mL 24 microplates 8 deep-well plates 4 square-well plates	J-TB-089

^a Maximum speeds are based on a solution density of 1.2 g/mL in all rotors.

^b Maximum speed for the rotor in the Avanti® J-E centrifuge.

^c At 35°C ambient temperature and 95 percent humidity.

^d Maximum speed in the Avanti J-E for the rotor with magnets; without magnets maximum is 14 000 rpm. (Maximum speed at 2°C in a 50-Hz centrifuge is 14 000 rpm.)

^e Maximum speed for rotor without magnets is 13 000 rpm.

^f Temperature performance for the F14BCI-14x50cy rotor in the Avanti J-E is as follows: 12°C minimum at 14 000 rpm (at 35°C ambient), 4°C minimum at 13 000 rpm (35°C ambient).

^g Maximum speed for rotor without magnets is 6 300 rpm.

Preinstallation requirements have been provided for your Avanti® J-E centrifuge. The following information is included in case the instrument must be relocated. (After the centrifuge is moved it must be leveled by adjusting the two front feet.)

If it is necessary to move the centrifuge, maintain the following conditions.

- Select a location away from heat-producing laboratory equipment, with sufficient ventilation to allow for heat dissipation.
- The centrifuge must have adequate air ventilation to ensure compliance to local requirements for vapors produced during centrifuge operation.
- Position the centrifuge on a level floor that can support the weight of the centrifuge and resist vibration.
- In addition to space for the instrument itself, allow a 7.7-cm (3-in.) clearance on each side of the instrument and a 16-cm (6.25-in.) clearance behind the instrument for circulation. The centrifuge must have adequate air ventilation to ensure compliance to local requirements for vapors produced during operation.

Figure 2-1. Dimensions of the Avanti-E Centrifuge

- Position the centrifuge so that the air diverter nearly touches the wall behind the centrifuge. Place the power cord to one side of the air diverter. To avoid damaging the power cord when installing or moving the centrifuge, be sure to remove the cord out of the way before pushing the centrifuge toward the wall.
- Relative humidity should not exceed 95% (noncondensing).

ELECTRICAL REQUIREMENTS

200-V centrifuge	180–220 VAC, 24 A, 50/60 Hz
230-V centrifuge	207–253 VAC, 24A, 50/60 Hz
208/240-V centrifuge.	187–229/216–264 VAC, 24A, 50 Hz

To reduce the risk of electrical shock, this centrifuge uses a permanently attached 1.8-m (6-ft) three-wire UL/CSA approved electrical cord and plug to connect the centrifuge to earth-ground. (Contact your local Beckman Coulter office for specific information regarding local plug requirements.) To preserve this safety feature:

- Power to the centrifuge should originate directly from a main power line transformer at a power source known to be clear of erratic loads, spikes, and electromagnetic interference. Make sure there are properly rated thermal circuit breakers at the wall service panel to protect the centrifuge circuit. If fuses must be used instead of the specified circuit breakers, the fuses may require a rating of greater than 30 amperes. Figure 2-2 shows the power connection.

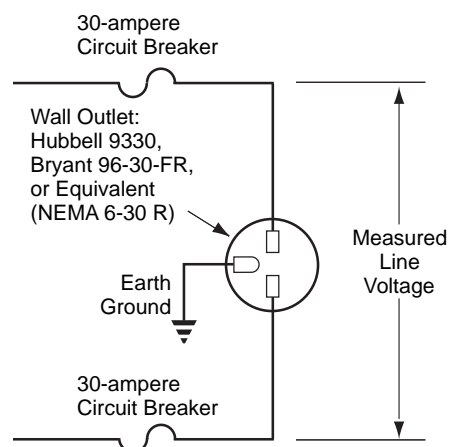

Figure 2-2. Single-Phase Power Connection

BIO-SAFETY LEVEL 3 INSTALLATION

For laboratories with epoxy aggregate floors, such as BSL-3 labs, a non-invasive installation kit (PN 393830) is available. The kit which consists of an adhesive-backed mounting plate, is CSA certified for use on epoxy aggregate floors only.

This section contains manual and programmed operating procedures.
A summary is provided at the start of



WARNING

Do not use the centrifuge in the vicinity of flammable liquids or vapors, and do not run such materials in the instrument. Do not lean on the instrument or place items on it while it is operating.

SUMMARY OF RUN PROCEDURES

For runs at other than room temperature, refrigerate or warm the rotor beforehand for fast equilibration.

PROGRAMMED RUN

1	POWER	Turn the power switch on).
2	[DOOR]	Press [DOOR] to unlock the chamber door; lift the door open.
3		Install the rotor according to the applicable rotor manual, then close the chamber door and press [DOOR].
4	[PROGRAM]	Press [PROGRAM], use the keypad to enter the required program number, then press [ENTER]. Press [SHOW SET] to display program parameters.
5	[ENTER] [START]	Check that all parameters are correct and that the door is closed. Press [ENTER], then press [START] (within 5 seconds).
6	[STOP]	Wait for the run to end, or end the run by pressing [STOP].
7	[DOOR]	When the rotor stops (a tone sounds), press [DOOR] to unlock the chamber door; lift the door open to remove the rotor.

MANUAL RUN

- | | | |
|----|--------------------|---|
| 1 | POWER | Turn the power switch on. |
| 2 | [DOOR] | Press [DOOR] to unlock the chamber door; lift the door open. |
| 3 | | Install the rotor according to the applicable rotor manual, then close the chamber door and press [DOOR]. |
| 4 | [ROTOR] | Press [ROTOR], then use the keypad to enter the rotor entry code. |
| 5 | [RPM/RCF] | Press [RPM/RCF], then use the keypad to enter the run speed (300 to 21 000 rpm). Press [RPM/RCF] a second time to enter speed in RCF. |
| 6 | [TIME] | Press [TIME], then use the keypad to enter the run time (to 99 hrs, 59 minutes); or press [TIME] twice for a hold (continuous) run. |
| 7 | [TEMP °C] | Press [TEMP °C], then use the keypad to enter the required run temperature (–10 to +40°C). |
| 8 | [ACCEL] | Press [ACCEL], then use the keypad to enter the selected acceleration rate number, 1 or 2. |
| 9 | [DECEL] | Press [DECEL], then use the keypad to enter the selected deceleration rate number, 1, 2, or 3. |
| 10 | [ENTER]
[START] | Check that all parameters are correct and that the door is closed. Press [ENTER], then press [START] (within 5 seconds). |
| 11 | [STOP] | |

PREPARATION

Prepare the rotor for centrifugation as described in the applicable rotor manual. For runs at other than room temperature, refrigerate or warm the rotor beforehand for fast equilibration.

INSTALLING THE ROTOR

The power must be turned on before you can unlock and open the chamber door. (To end a run for any reason, do not turn the power switch off; press [TOP] instead.)

Action	Result
1. Turn the power switch on.	Indicator lights on the control panel light up.
2. Press [DOOR] to unlock the door.	The instrument will accept this command only when the rotor is at rest.
3. Lift the door up to open.	



CAUTION

4. Install the rotor according to directions in the rotor manual. Ensure that the rotor is seated on the drive hub. Avoid bumping the control panel keys during rotor installation or removal. (If you bump the control panel and an L1 diagnostic appears, press [F] to clear the message.)

Rotors used in Avantis series centrifuges must have drive pins in the rotor drive hole. These drive pins engage with the centrifuge drive hub.

Action	Result
5. Close the chamber door and press [DOOR]. (To keep the chamber clean and dry, leave the door closed whenever possible.)	The door latches. When the latches engage, the LED next to the [DOOR] key lights.

MANUAL OPERATION

- When a run-parameter key ([TOR], [RPM/RCF], [TIME], [TEMP], [ACCEL], or [DECEL]) is pressed, a parameter can be entered or changed. Entry is completed when [ENTER] or another function key is pressed.
- To change an entry before you've pressed [ENTER] or another parameter key, press [] and enter a different value. To change an entry after you've pressed [ENTER], press the run-parameter key again.
- If an unacceptable value is entered, the valid range for that parameter is displayed in the message line. Enter the correct value.

SELECTING A ROTOR

Action	Result
1. Press [ROTOR].	A list of rotors, with rotor entry codes, scrolls across the display.
2. Use the keypad to select a rotor by entry code number.	<p>NOTE</p> <p>An alternate method of selecting a rotor is to press [ROTOR] repeatedly; the rotor number changes each time the key is pressed. When the rotor you are using is displayed, press [ENTER].</p>
3. Press the next run-parameter key or press [ENTER].	

ENTERING RUN SPEED

Enter a run speed up to the maximum speed of the rotor in use (21 000 rpm maximum). Or, enter a relative centrifugal field (RCF) value up to the maximum allowable RCF of the rotor.

Action	Result
1. Press [RPM/RCF] once to enter speed in RPM or twice to enter speed in RCF.	Allowed speed for the selected rotor is displayed.
2. Use the keypad to enter required speed.	Entered speed appears.

Action	Result
1. Press [IME].	The cursor appears.
2. Use the keypad to enter required time.	Entered time appears on the display. If you entered a number higher than 59 minutes, the centrifuge automatically recalculates the time in hours and minutes.
or	
Press [IME] again for a hold run.	HOLD appears on the display.

ENTERING ACCELERATION AND DECELERATION RATES

The instrument provides a choice of two acceleration rates and three deceleration rates to protect the gradient and sample-to-gradient interface. The acceleration time is the time it takes a rotor to reach set speed from rest. The deceleration time is the time it takes a rotor to decelerate from set speed to rest.

Action	Result
1. Press [ACCEL] .	Acceleration options are displayed.
2. Press the keypad number for the required acceleration rate—1 = MAX, 2 = SLOW.	Entered acceleration rate appears on the display.
3. Press the next run-parameter key or [ENTER] .	
4. Press [DECCEL] .	Deceleration options are displayed.
5. Press the keypad number for the required deceleration rate—1 = MAX; 2 = SLOW; 3 = OFF.	Entered deceleration rate appears on the display.

STARTING A RUN

Action	Result
1. Press [ENTER] and [START].	The green light next to the [START] key flashes and the rotor begins to spin.

NOTE

To begin a run, [ENTER] must always be the last key pressed before pressing [START]. If you wait more than 5 seconds, the [START] key will not activate. If this happens, press [ENTER] and [START] again to begin the run.

If an unacceptable value was ~~note~~ **error**, the run will not begin when [ENTER] and [START] are pressed. Check the display and make any necessary corrections or additions. Press [ENTER] and [START] again to begin the run.

The run will end when the time display counts down to zero. (Press [STOP] to terminate a run for any reason.) The green light next to the [STOP] key will flash while the rotor decelerates. A tone sounds when the rotor comes to a complete stop.

- | | |
|---|-----------------------|
| 2. After the rotor has stopped, press [DOOR]. | The door is unlocked. |
| 3. Remove the rotor. Keep the chamber door closed between runs. | |

PROGRAMMED OPERATION

The instrument internal memory can store up to nine programs which can be recalled by keypad numbers 1 through 9. Saved programs are retained in memory even if the power is turned off. Procedures for entering run parameters are the same for programmed operation as those described above for manual operation.

Action	Result
3. Press [HOW SET] .	The number you selected will appear in the program display. Run parameters for that program will be displayed for 5 seconds. (To make changes, see Changing a Program, below.)
4. Press [ENTER] and [START] to begin the programmed run (or press [PROGRAM] to exit program mode and return to manual operation).	The run starts, the green light next to the [START] key flashes, and the rotor begins to spin.

NOTE

To begin a run, [ENTER] must always be the last key pressed before pressing [START] . If you wait more than 5 seconds, the [START] key will not activate. If this happens, press [ENTER] and [START] again to begin the run.

If an unacceptable value was entered, the run will not begin when [ENTER] and [START] are pressed. Check each display and make any necessary corrections or additions. Press [ENTER] and [START] again to begin the run.

The run will end automatically when the time display counts down to zero. (Press [TOP] to terminate a run at any time.) The green light next to the [TOP] key will flash while the rotor decelerates. A tone will sound when the rotor has come to a complete stop.

- | | |
|---|-----------------------|
| 5. After the rotor has stopped, press [DOOR] . | The door is unlocked. |
| 6. Remove the rotor. Keep the chamber door closed between runs. | |

RECALLING AND CHANGING A PROGRAM

Recalling a Program

A program that has been saved in memory can be recalled at any time.

Operation

Action

This section lists possible malfunc

the field service representative diagnose and correct the problem, try to gather as much information about the situation as you can, including:

- the diagnostic number and message,
- the operating situation when the diagnostic condition occurred (such as rotor in use, speed, or load type), and
- any unusual environmental and/or operating conditions (such as ambient temperature or voltage fluctuations).

Table 4-1. Diagnostic Message Chart

Diagnostic Number/ Message	Problem	Result	Recommended Action
P1– Power failure occurred, see manual	Momentary power failure: rotor does not come to a complete stop	Run continues when power resumes	Press [CE] to clear message.
P2– Power failure, see manual	Power failure: rotor speed drops to <500 rpm	Run restarts automatically when power resumes	Press [CE] to clear message.
L1, L2, L5, L6, L11, and L12– Reclose door	Latches are not operating properly	Error message appears; run shuts down with maximum brake	Press down on the door and press [DOOR]. If you close the door repeatedly and the problem continues, gently clean the latch area with a lintless swab. Be careful not to damage sensitive electronics in the area. WARNING: Do not put your fingers into the latch openings. Press [CE] to clear message.
C1– Rotor temp exceeds 4C above Tf 0.00d u.0031 Tc 43.004 Tw 10.7112.333 TRrotitivem propure			

Continued—

Table 4-1. Diagnostic Message Chart (continued)

Diagnostic Number/ Message	Problem	Result	Recommended Action
C5– Temp, call service	Refrigeration system error	Run shuts down with maximum brake	Call Beckman Coulter service.
T1 through T4– Temp, call service	System temperature problem	Run shuts down with maximum brake	Call Beckman Coulter service.
D1 through D12, D14, and D15– Drive, call service	Drive system problem	Run stops, usually with no brake. Door may not unlock for up to an hour.	Call Beckman Coulter service. Before trying to open the door, listen carefully and make sure that no sound is coming from the chamber (indicating a spinning rotor). Follow the directions under ACCESSING THE ROTOR IN CASE OF POWER FAILURE, below.
D13– No rotor in chamber or drive problem	There is no rotor installed or the drive belt is loose or broken	Run shuts down with maximum brake.	<ul style="list-style-type: none"> • Install rotor per the applicable rotor manual. • If the rotor is installed when the message appears, call Beckman Coulter service.
F1 and F2– FRS,* call service	Required vacuum level not reached in allowed time	Run shuts down with maximum brake	<ul style="list-style-type: none"> • Check and clean door sealing area and door gasket. • Wipe any ice and excess moisture from chamber. • Call Beckman Coulter service.
R1, and R2– Rotor, ID problem	No magnets identified, or magnets incorrectly identified	Run continues, speed may be derated	Press [CE] to clear message. If problem repeats, check rotor magnets or call Beckman Coulter service.
R3, R4, and R8– Rotor, speed derated	The entered rotor number is not the same as the rotor identified	If identified rotor speed maximum is lower than entered maximum, the speed will be reduced to the rated maximum of the installed rotor	Press [CE] to clear message. Enter the correct rotor entry code.
R5 and R6– No rotor match	The system cannot identify the rotor	Run shuts down with maximum brake	<ul style="list-style-type: none"> • Make sure the rotor in use is a compatible Beckman Coulter rotor (see AVAILABLE ROTORS in Section 1). • Call Beckman Coulter service.
R9– Calibration error	Rotor calibration error	Run shuts down with maximum brake	<ul style="list-style-type: none"> • Make sure the rotor in use is a compatible Beckman Coulter rotor (see AVAILABLE ROTORS in Section 1). • Call Beckman Coulter service.

* Friction Reduction System.

Continued—

Table 4-1. Diagnostic Message Chart (continued)

Diagnostic Number/ Message	Problem	Result	Recommended Action
S1 through S14— System error, call service	There is a problem with the system control soft- ware, EPROM, or RAM	System shuts down	Call Beckman Coulter service.
H1, H5, H7, and H8— Speed, call service	Speed control problem	Run shuts down with maximum brake; door may not unlock for up to an hour.	Call Beckman Coulter service.
H2, H3, and H11— Speed, call service	Speed control problem	Run stops, usually with no brake	Call Beckman Coulter service.
H4, H6, and H9— Speed error	Accel or decel speed problem	Run continues	Press [CE] to clear message.
I1— Rotor imbalance	Rotor load is severely out of balance	Run shuts down with maximum brake	<ul style="list-style-type: none"> • Make sure that tubes or bottles are loaded symmetrically in the rotor. • With swinging bucket rotors, remove the buckets and lubricate the pivot pins where the buckets contact as described in the applicable rotor manual. Unlubricated pivot pins can prevent the buckets from reaching horizontal position, which can cause imbalance.
—	During low-tempera- ture runs (near -10°C), ice forms around the door opening	Door will not open at the end of a run	To minimize icing, wipe moisture from the chamber, the chamber gasket and the inner door surface before each run. Keep the door closed as much as possible.

RETRIEVING YOUR SAMPLE IN CASE OF POWER FAILURE

If facility power fails only momentarily, the instrument will resume operation when power is restored and the rotor will return to set speed. However, if the rotor came to a complete stop, you will have to restart the run when the power is restored. In either case, a power outage message will be displayed on the control panel to indicate that a power outage has occurred.

**WARNING**



Any maintenance procedure requiring removal of a panel exposes the operator to the possibility of electrical shock and/or mechanical injury. Therefore, turn the power off and disconnect the instrument from the main power source, and refer such maintenance to service personnel.

In the event of an extended power failure, it may be necessary to override the door-locking mechanism manually to remove the rotor and retrieve your sample.

**WARNING**

The following procedure should be implemented only when absolutely necessary. TcT6-4(JTJ ET q 234 543.9)

Figure 4-1. Manual Door Release

Action	Result
3. Lower the panel as far as the tether cords allow.	 CAUTION Do not attempt to remove tether cords. They are required to assure safe operation of the centrifuge.
4. Use the latch override key (368247) to turn the right-hand latch bolt to the right (clockwise) and the left-hand latch bolt to the left (counter-clockwise) until the latches release.	If the rotor is still spinning, close the door and turn the latches to secure it. Wait until the rotor stops spinning to repeat this step.  WARNING NEVER try to slow or stop the rotor by hand.
5. After removing the rotor, replace the top frontlowv-5(nt)-5(l)b	

- Clean the drive hub regularly us

While Beckman Coulter has tested 70% ethanol (70%) and found that it does not damage the centrifuge, no guarantee of sterility or disinfection is expressed or implied. When sterilization or disinfection is a concern, consult your laboratory safety officer regarding proper methods to use.

REPLACING THE AIR FILTER

Check the air filter (Figure 5-1) regularly and replace it about once a year, or more often if it looks dirty. The air filter is not fastened to the centrifuge, so no tools are required for removal or installation.

1. To remove the air filter, grasp the top edge and lift the filter straight up.
2. Install a new filter by holding the top edge and inserting the bottom edge into the slot in the deflector strip. Lower the filter until the bottom edge rests on the brackets.

Figure 5-1. Air Filter Replacement

CIRCUIT BREAKER AND FUSES

There are no user-replaceable fuses in the centrifuge.

If the centrifuge circuit breaker trips for any reason, the power switch will move to the OFF (O) position. Reset the circuit breaker by turning the power switch back to the ON (I) position. If it trips again immediately, do not reset it. Call Beckman Coulter Field Service.



CAUTION

Repeated attempts to reset the centrifuge circuit breaker can cause substantial damage to electrical and electronic components.

STORAGE AND TRANSPORT

STORAGE

To ensure that the centrifuge does not get damaged, contact Beckman Coulter Field Service for specific instructions and/or assistance in preparing the equipment for transport or long-term storage. Temperature and humidity conditions for storage should meet the environmental requirements described under SPECIFICATIONS.

SUPPLY LIST

NOTE

Publications referenced in this manual can be obtained by calling Beckman Coulter at 1-800-742-2345 in the United States, or by contacting your local Beckman Coulter office.

Contact Beckman Coulter Sales at 1-800-742-2345 in the United States; worldwide offices are listed on the back cover of this manual) for information about ordering parts and supplies. A partial list of supplies is given below for your convenience. See the Beckman Coulter High Performance, High Speed, High Capacity Rotors, Tubes & Accessories catalog (BR-8102, available at www.beckman-coulter.com) for detailed information on ordering rotors, tubes, and accessories.

REPLACEMENT PARTS

Air filter 978347Maemory

AVANTI® J-E CENTRIFUGE WARRANTY

Subject to the exceptions and upon the conditions specified below Beckman Coulter agrees to correct either by repair, or, at its election, by replacement any defects of material or workmanship which develop within one (1) year (2 years for the drive motor) after delivery of the Avanti-E Centrifuge centrifuge (the product), to the original buyer by Beckman Coulter or by an authorized representative, provided that investigation and factory inspection by Beckman Coulter discloses that such defect developed under normal and proper use.

Some components and accessories by their nature are not intended to and will not function for as long as one (1) year. If any such component or accessory fails to give reasonable ser-



Beckman Coulter, Inc. • 250 S. Kraemer Blvd. • Brea, California 9282
Sales and Service: 1-800-742-2345 • Internet: www.beckmancoulter.com

©2009 Beckman Coulter, Inc.
All rights reserved